

A Basic Introduction to Rheology

Rheometry refers to the experimental technique used to determine the rheological properties of materials; rheology being defined as the study of the flow and deformation of matter which describes the interrelation between force, deformation and time. The term rheology originates from the Greek words 'rheo' translating as 'flow' and 'logia' meaning 'the study of', although as from the definition above, rheology is as much about the deformation of solid-like materials as it is about the flow of liquid-like materials, and in particular deals with the behavior of complex visco-elastic materials that show properties of both solids and liquids in response to force, deformation, and time.

There are a number of rheometric tests that can be performed on a rheometer to determine flow properties and visco-elastic properties of a material and it is often useful to deal with them separately. Hence for the first part of this introduction, the focus will be on flow and viscosity and the tests that can be used to measure and describe the flow behavior of both simple and complex fluids. In the second part, deformation and viscoelasticity will be discussed.

Viscosity

There are two basic types of flow, these being shear flow and extensional flow. In shear flow fluid, components shear past one another while in extensional flow fluid, components flow away or towards one other. The most common flow behavior and one that is most easily measured on a rotational rheometer or viscometer is shear flow, and this viscosity introduction will focus on that behavior and how to measure it.

Shear Flow

Shear flow can be depicted as layers of fluid sliding over one another with each layer moving faster than the one beneath it. The uppermost layer has maximum velocity while the bottom layer is stationary. For shear flow to take place, a shear force must act on the fluid. This external force takes the form of a shear stress (σ) which is defined as the force (F) acting over a unit area (A) as shown in Figure 1. In response to this force, the upper layer will move a given distance x , while the bottom layer remains stationary. Hence, we have a displacement gradient across the sample (x/h) termed the shear strain (γ). For a solid, which behaves like a single block of material, the strain will be finite for an applied stress – no flow is possible. However, for a fluid, where the constituent components can move relative to one another, the shear strain will continue to increase for the period of applied stress. This creates a velocity gradient termed the shear rate or strain rate ($\dot{\gamma}$) which is the rate of change of strain with time ($d\gamma/dt$).

When we apply a shear stress to a fluid, we are transferring momentum, indeed the shear stress is equivalent to the momentum flux or rate of momentum transfer to the upper layer of fluid. That momentum is transferred through the layers of fluid by collisions and interactions with other fluid components giving a reduction in fluid velocity and kinetic energy. The coefficient of proportionality between the shear stress and shear rate is defined as the shear viscosity or dynamic viscosity (η), which is a quantitative measure of the internal fluid friction, and is associated with damping or loss of kinetic energy in the system.

$$\eta = \sigma / \dot{\gamma} \text{ (Pa.s)}$$

$$\sigma = F/A \text{ (Pa)}$$

$$\gamma = x/h$$

$$\dot{\gamma} = d\gamma/dt \text{ (s}^{-1}\text{)}$$

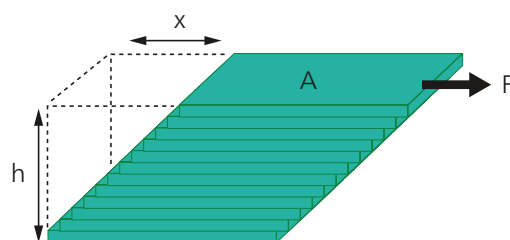

1 Quantification of shear rate and shear stress for layers of fluid sliding over one another

A Basic Introduction to Rheology

Newtonian and Non-Newtonian Fluids

Newtonian fluids are fluids in which the shear stress is linearly related to the shear rate, and hence, the viscosity is invariable with shear rate or shear stress. Typical Newtonian fluids include water, simple hydrocarbons and dilute colloidal dispersions. Non-Newtonian fluids are those in which the viscosity varies as a function of the applied shear rate or shear stress.

It should be noted that fluid viscosity is both pressure and temperature dependent, with viscosity generally increasing with increased pressure and decreasing temperature. Temperature is more critical than pressure in this regard, with higher viscosity fluids such as asphalt or bitumen, much more temperature dependent than low-viscosity fluids such as water.

Rotational Rheometer

To measure shear viscosity using a single head rotational rheometer with parallel plate measuring systems, the sample is loaded between the plates at a known gap (h) as shown in Figure 2. Single head rheometers are capable of working in controlled stress or controlled rate mode which means it is possible to apply a torque and measure the rotational speed or alternatively apply a rotational speed and measure the torque required to maintain that speed. In controlled stress mode, a torque is requested from the motor, which translates to a force (F) acting over the surface area of the plate (A) to give a shear stress (F/A). In response to an applied shear stress, a liquid-like sample will flow with a shear rate dependent on its viscosity. If the measurement gap (h) is accurately known, the shear rate (V/h) can be determined from the measured

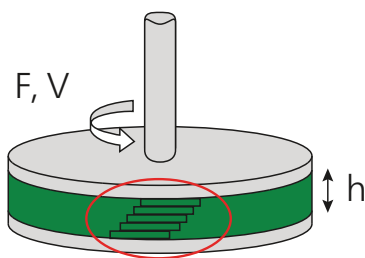

2 Illustration showing a sample loaded between parallel plates and shear profile generated across the gap

angular velocity (ω) of the upper plate, which is determined by high precision position sensors, and the plate radius (r), since $V = r \omega$.

Other measuring systems including cone-plate and concentric cylinders are commonly used for measuring viscosity, with cone-plate often preferred since the shear rate is constant across the sample. The type of measuring system used and its dimensions depend on the sample type and its viscosity. For example, when working with large particle suspensions, a cone-plate system is often not suitable, while a measuring system with a larger surface area such as a double gap concentric cylinder can be preferable for measuring low viscosity and volatile fluids.

Shear Thinning

The most common type of non-Newtonian behavior is shear thinning or pseudoplastic flow, where the fluid viscosity decreases with increasing shear. At low enough shear rates, shear thinning fluids will show a constant viscosity value, η_0 termed the zero-shear viscosity or zero-shear viscosity plateau. At a critical shear rate or shear stress, a large drop in viscosity is observed which signifies the beginning of the shear thinning region. This shear thinning region can be mathematically described by a power-law relationship, which appears as a linear section when viewed on a double logarithmic scale (Figure 3) – this is how rheological flow curves are often presented. At very high shear rates, a second constant viscosity plateau is observed, called the infinite shear viscosity plateau. This is given the symbol η_∞ and can be several orders of magnitude lower than η_0 depending on the degree of shear thinning.

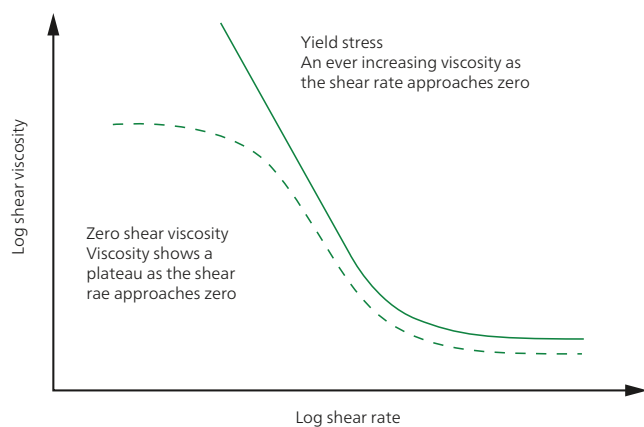

3 Typical flow curves for shear thinning fluids with a zero shear viscosity and an apparent yield stress

Some highly shear-thinning fluids also appear to have what is termed a yield stress, where below some critical stress, the viscosity becomes infinite and hence characteristic of a solid. This type of flow response is known as plastic flow and is characterized by an ever increasing viscosity as the shear rate approaches zero (no visible plateau). Many prefer the description ‘apparent yield stress’ since some materials which appear to demonstrate yield stress behavior over a limited shear rate range may show a viscosity plateau at very low shear rates.

Why does shear thinning occur? Shear thinning is the result of micro-structural rearrangements occurring in the plane of applied shear and is commonly observed for dispersions, including emulsions and suspensions, as well as polymer solutions and melts. An illustration of the types of shear induced orientation which can occur for various shear thinning materials is shown in Figure 4.

At low shear rates, materials tend to maintain an irregular order with a high zero shear viscosity (η_0) resulting from particle/molecular interactions and the restorative effects of Brownian motion. In the case of yield stress materials, such interactions result in network formation or jamming of dispersed elements, which must be broken

or unjammed for the material to flow. At shear rates or stresses high enough to overcome these effects, particles can rearrange or reorganize in to string-like layers, polymers can stretch out and align with the flow, aggregated structures can be broken down and droplets deformed from their spherical shape. A consequence of these rearrangements is a decrease in molecular/particle interaction and an increase in free space between dispersed components, which both contribute to the large drop in viscosity. η_∞ is associated with the maximum degree of orientation achievable and hence the minimum attainable viscosity – this is influenced largely by the solvent viscosity and related hydrodynamic forces.

Model Fitting

The features of the flow curves shown in Figure 3 can be adequately modeled using some relatively straight forward equations. The benefits of such an approach are that it is possible to describe and compare the shape and curvature of a flow curve through a relatively small number of fitting parameters and to predict behavior at unmeasured shear rates (although caution is needed when using extrapolated data).

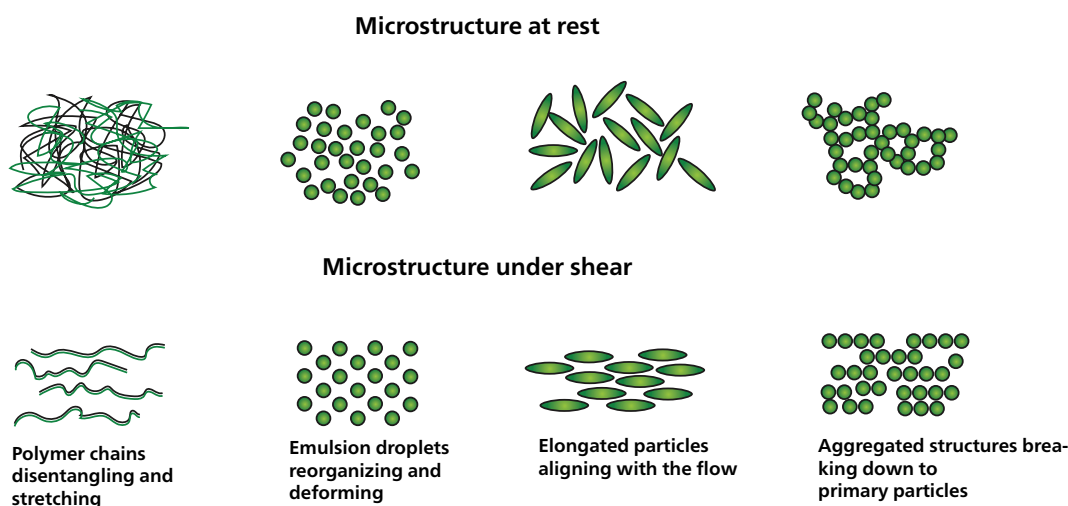

4 Illustration showing how different micro-structures might respond to the application of shear

Three of the most common models for fitting flow curves are the Cross, Power-law and Sisko models. The most applicable model largely depends on the range of the measured data or the region of the curve you would like to model (Figure 5). There are a number of alternative models available such as the Carreau-Yasuda model and Ellis models for example. Other models accommodate the presence of a yield stress; these include Casson, Bingham, and Herschel-Bulkley models.

Cross model
$$\frac{\eta - \eta_{\infty}}{\eta_0 - \eta_{\infty}} = \frac{1}{1 + (K\dot{\gamma})^m}$$

Power law model
$$\sigma = K\dot{\gamma}^n$$

Sisko Model
$$\sigma = K\dot{\gamma}^n + \eta_{\infty}\dot{\gamma}$$

η_0 is the zero shear viscosity; η_{∞} is the infinite shear viscosity; K is the cross constant, which is indicative of the onset of shear thinning; m is the shear thinning index which ranges from 0 (Newtonian) to 1 (Infinitely shear thinning); n is the power law index which is equal to $(1 - m)$, and similarly related to the extent of shear thinning but with $n \rightarrow 1$ indicating a more Newtonian response; k is the consistency index which is numerically equal to the viscosity at 1 s^{-1} .

Shear Thickening

While most suspensions and polymer structured materials are shear thinning, some materials can also show shear thickening behavior where viscosity increases with increasing shear rate or shear stress. This phenomenon is often called dilatancy, and although this refers to a specific mechanism for shear thickening associated with a volume increase, the terms are often used interchangeably.

In most cases, shear thickening occurs over a decade of shear rates and there can be a region of shear thinning at lower and higher shear rates. Usually, dispersions or particulate suspensions with a high concentration of solid particles exhibit shear thickening. Materials exhibiting shear thickening are much less common in industrial applications than shear thinning materials. They do have some useful applications such as in shock absorbers and high impact protective equipment but for the most part, shear thickening is an unwanted effect which can lead to major processing issues.

For suspensions, shear thickening generally occurs in materials that show shear thinning at lower shear rates and stresses. At a critical shear stress or shear rate, the organized flow regime responsible for shear thinning is disrupted and so called 'hydro-cluster' formation or 'jamming' can occur. This gives a transient solid-like response and an increase in the observed viscosity. Shear thickening can also occur in polymers, in particular amphiphilic polymers, which at high shear rates may open-up and stretch, exposing parts of the chain capable of forming transient intermolecular associations.

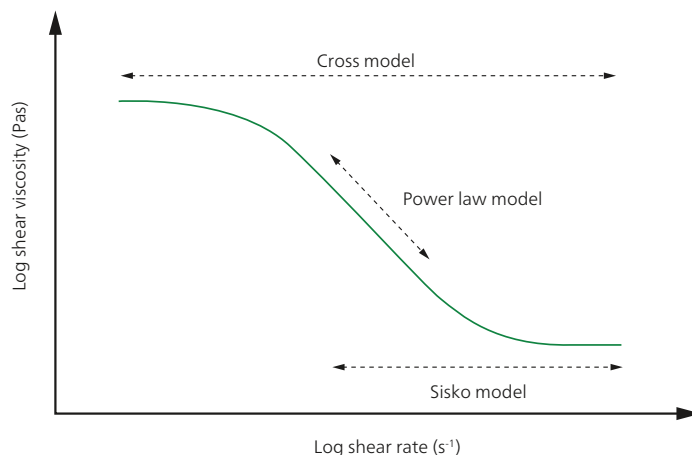

5 Illustration of a flow curve and the relevant models for describing its shape

Thixotropy

For most liquids, shear thinning is reversible and the liquids will eventually gain their original viscosity when the shearing force is removed. When this recovery process is sufficiently time dependent, the fluid is considered to be thixotropic. Thixotropy is related to the time dependent microstructural rearrangements occurring in a shear thinning fluid following a step change in applied shear (Figure 6). A shear thinning material may be thixotropic but a thixotropic material will always be shear thinning. A good practical example of a thixotropic material is paint. A paint should be thick in the can when stored for long periods to prevent separation but should thin down easily when stirred for a period time – hence it is shear thinning. Most often, its structure does not rebuild instantaneously on ceasing stirring – it takes time for the structure and hence viscosity to rebuild to give sufficient working time.

Thixotropy is also critical for leveling of paint once it is applied to a substrate. Here, the paint should have a low enough viscosity at application shear rates to be evenly distributed with a roller or brush, but once applied should recover its viscosity in a controlled manner. The recovery time should be short enough to prevent sagging but long enough for brush marks to dissipate and a level film to be formed. Thixotropy also affects how thick a material will

appear after it has been processed at a given shear rate, which may influence customer perception of quality, or whether a dispersion is prone to separation and/or sedimentation after high shear mixing, for example.

The best way to evaluate and quantify thixotropy is using a three-step shear test as shown in Figure 7. A low shear rate is employed in stage one, which is meant to replicate the samples at near rest behavior. In stage two, a high shear rate is applied for a given time to replicate the breakdown of the sample's structure and can be matched to the process of interest. In the third stage, the shear rate is again dropped to a value generally equivalent to that employed in stage one and viscosity recovery followed as a function of time. To compare thixotropic behavior between samples, the time required to recover 90% (or a defined amount) of the initial viscosity can be used. This time can therefore be viewed as a relative measure of thixotropy - a small rebuild time indicates that the sample is less thixotropic than a sample with a long rebuild time.

As well as monitoring viscosity recovery following application of high shear, it is also possible to work in oscillatory mode either side of an applied shear rate step and therefore directly monitor changes in G' (elastic structure) with time. See the section on visco-elasticity for more details on this test mode.

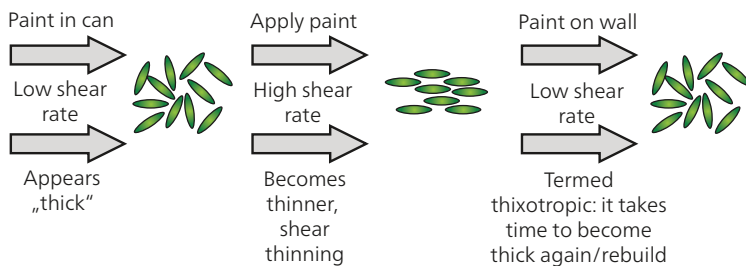

6 Illustration of thixotropy due to particle orientation before during and after shear flow for a paint sample

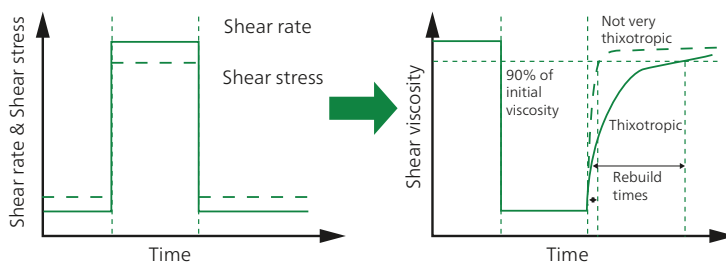

7 Illustration showing a step shear rate test for evaluating thixotropy and expected response for non-thixotropic and thixotropic fluids

Yield Stress

Many shear-thinning fluids can be considered to possess both liquid and solid like properties. At rest, these fluids are able to form intermolecular or interparticle networks as a result of polymer entanglements, particle association, or some other interaction. The presence of a network structure gives the material predominantly solid-like characteristics associated with elasticity, the strength of which is directly related to the intermolecular or interparticle forces (binding force) holding the network together, and hence its yield stress.

If an external stress is applied which is less than the yield stress, the material will deform elastically. However, when the external stress exceeds the yield stress, the network structure begins to collapse and the material will start flowing as if it is a liquid. Despite yield stress clearly being apparent in a range of daily activities such as squeezing toothpaste from a tube or dispensing ketchup from a bottle, the concept of a true yield stress is still a topic of much debate.

While a glassy liquid and an entangled polymer system will behave like a solid when deformed rapidly, at longer deformation times, these materials show properties of a liquid and hence do not possess a true yield stress. For this reason, the term 'apparent yield stress' is widely used. Figure 8 shows a plot of shear stress against shear rate for various fluid types. Materials which behave like

fluids at rest will have curves that meet at the origin, since any applied stress will induce a shear rate flow. For yield stress fluids, the curves will intercept the stress axis at a non-zero value indicating that a shear rate can only be induced when the yield stress has been exceeded. A Bingham plastic is one that has a yield stress but shows Newtonian behavior after yielding. This idealized behavior is rarely seen and most materials with an apparent yield stress show non-Newtonian behavior after yielding, which is generalized as plastic behavior.

There are a number of experimental tests for determining yield stress, including multiple creep testing, oscillation amplitude sweep testing and also steady shear testing; the latter usually with the application of appropriate models such as the Bingham, Casson and Herschel-Bulkley models.

Bingham $\sigma = \sigma_y + \eta_b \dot{\gamma}$

Herschel-Bulkley $\sigma = \sigma_y + K \dot{\gamma}^\eta$

where σ_y is the yield stress and η_b the Bingham viscosity, represented by the slope of shear stress versus shear rate in the Newtonian region, post yield. The Herschel-Bulkley model is just a power-law model with a yield stress term and hence represents shear thinning post yield, with K the consistency and η the power law index. All of the various tests for measuring yield stress are discussed in [5].

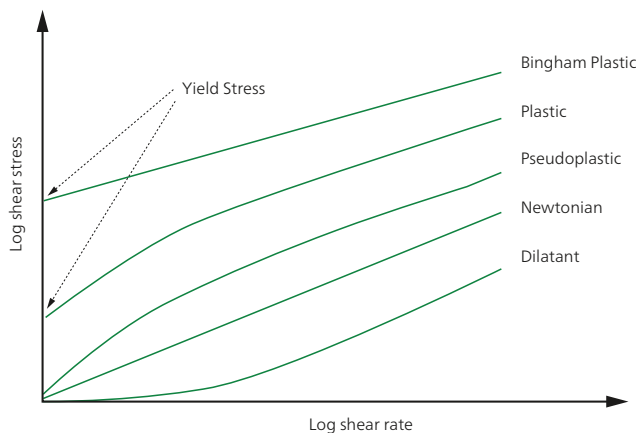

8 Shear stress/shear rate plots depicting various types of flow behavior

A Basic Introduction to Rheology

One of the quickest and easiest methods for measuring the yield stress is to perform a shear stress ramp and determine the stress at which a viscosity peak is observed (Figure 9). Prior to this viscosity peak, the material is undergoing elastic deformation where the sample is simply stretching. The peak in viscosity represents the point at which this elastic structure breaks down (yields) and the material starts to flow. If there is no peak, this indicates that the material does not have a yield stress under the conditions of the test.

Yield stress can be related to the stand-up properties (slump) of a material, the stability of a suspension, or sagging of a film on a vertical surface, as well as many other applications.

Viscoelasticity

As the name suggests, visco-elastic behavior describes materials which show behavior somewhere between that of

an ideal liquid (viscous) and ideal solid (elastic). There are a number of rheological techniques for probing the visco-elastic behavior of materials, including creep testing, stress relaxation and oscillatory testing. Since oscillatory shear rheometry is the primary technique that is used to measure viscoelasticity on a rotational rheometer, this will be discussed in greatest detail, although creep testing will also be introduced.

Elastic Behavior

Structured fluids have a minimum (equilibrium) energy state associated with their 'at rest' micro-structure. This state may relate to inter-entangled chains in a polymer solution, randomly ordered particles in a suspension, or jammed droplets in an emulsion. Applying a force or deformation to a structured fluid will shift the equilibrium away from this minimum energy state, creating an elastic force that tries to restore the micro-structure to its initial state.

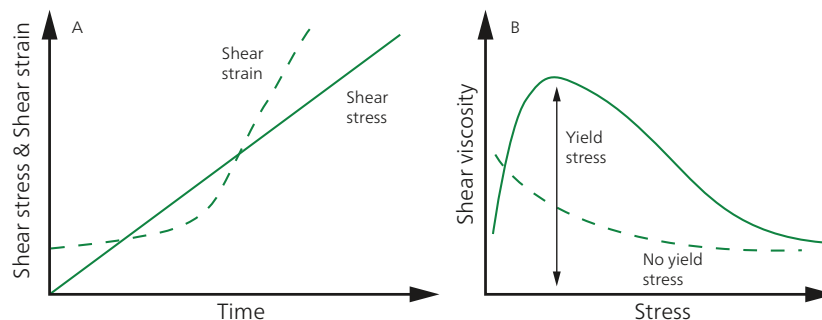

9 Linear shear stress ramp and shear strain response (left) and corresponding viscosity plotted against shear stress for materials with and without a yield stress

This is analogous to a stretched spring trying to return to its undeformed state. A spring is representative of a linear elastic solid that obeys Hooke's law, in that the applied stress is proportional to the resultant strain as long as the elastic limit is not exceeded, and will return to its initial shape when the stress is removed, as shown in Figure 10. If the elastic limit is surpassed, the relationship will become non-linear and the spring may be permanently distorted. These same principles can also be applied to simple shear deformation, as illustrated in Figure 11.

For simple shear elastic deformation, the constant of proportionality is the elastic modulus (G). The elastic modulus is a measure of stiffness or resistance to deformation just as viscosity is a measure of the resistance to flow. For a purely elastic material, there is no time dependence so when a stress is applied an immediate strain is observed, and when the stress is removed the strain immediately disappears.

This can be expressed as: $\gamma = \frac{\sigma}{G}$

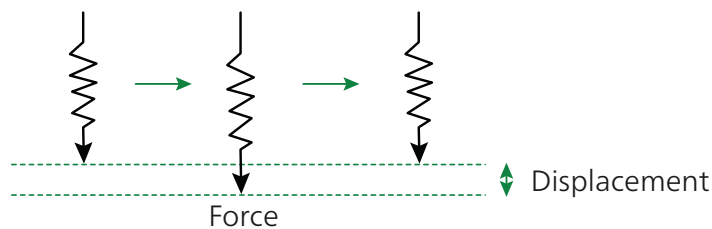

10 The response of an ideal (spring) to the application and subsequent removal of a strain including force

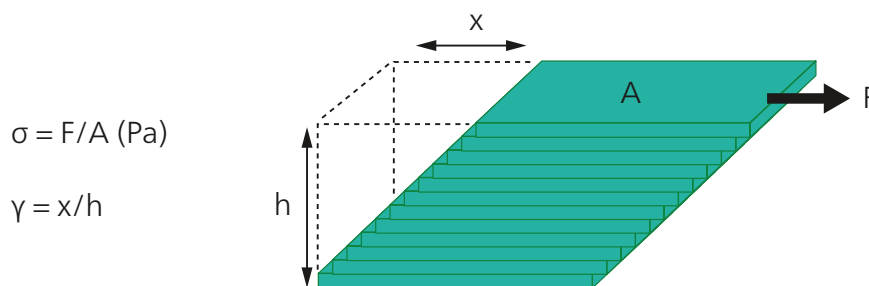

$\sigma = F/A$ (Pa)

$\gamma = x/h$

11 Quantification of stress, and strain for an ideal solid deforming elastically in shear

A Basic Introduction to Rheology

Viscous Behavior

Just as a spring is considered representative of a linear elastic solid that obeys Hooke's law, a viscous material can be modeled using a dashpot which obeys Newton's law. A dashpot is a mechanical device consisting of a plunger moving through a viscous Newtonian fluid the wall to support the applied stress [18, 21, and 22].

When a stress (or force) is applied to a dashpot, the dashpot immediately starts to deform and goes on deforming at a constant rate (strain rate) until the stress is removed (Figure 12). The energy required for the deformation or displacement is dissipated within the fluid (usually as heat) and the strain is permanent. The strain evolution in an ideal liquid is given by the following expression:

$$\gamma = \frac{\sigma t}{\eta}$$

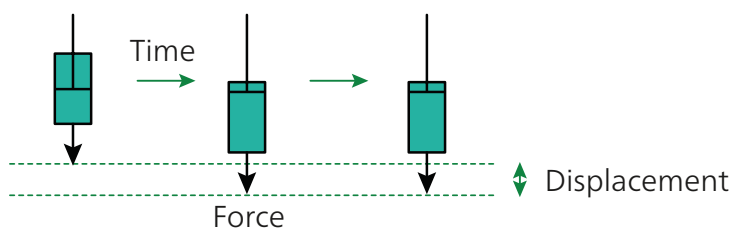

12 Response of an ideal liquid (dashpot) to the application and subsequent removal of a strain including a force

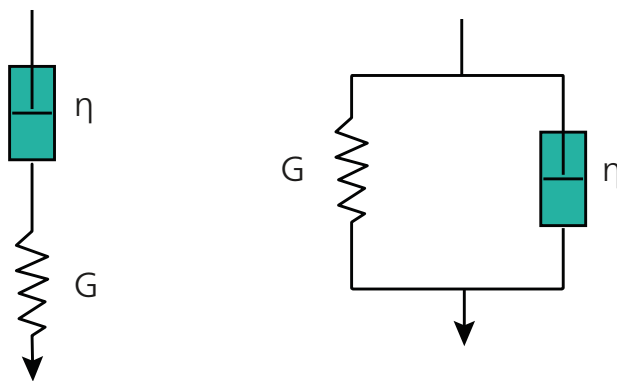

13 (Left) Maxwell model representative of a simple visco-elastic liquid; (right) Kelvin-Voigt model representative of a simple visco-elastic solid

Visco-Elastic Behavior

A vast majority of materials show rheological behavior that classifies them in a region somewhere between that of liquids and solids and are therefore classed as visco-elastic materials. Consequently, it is possible to combine springs and dashpots in such a way as to model or describe real viscoelastic behavior. The simplest representation of a visco-elastic liquid is a spring and dashpot connected in series, which is called the Maxwell model. A visco-elastic solid can be similarly represented by the Kelvin-Voigt model which utilizes the same combination of elements but connected in parallel (Figure 13).

A Basic Introduction to Rheology

If a stress is applied to a Maxwell model then at very short times the response is predominantly elastic and governed by G , while at much longer times viscous behavior prevails and response is governed largely by η . The strain evolution in a Maxwell model can be described by the following expression:

$$\gamma = \sigma \left(\frac{1}{G} + \frac{\sigma}{\eta} \right)$$

If a stress is applied to a Kelvin-Voigt model the strain takes time to develop since the presence of the dashpot retards the response of the spring and the system behaves like a viscous liquid initially and then elastically over longer time scales as the spring becomes more stretched. The timescale or rate at which this transition occurs depends on the retardation time λ , which is given by η/G . This can be defined as the time required for the strain to reach approximately 63% of its final asymptotic value. The strain evolution in a Kelvin-Voigt model can be described by the following expression.

$$\gamma = \frac{\sigma}{G} [1 - e^{-t/\lambda}]$$

The model which best describes the viscoelastic behavior of real systems in response to an applied stress is the Burgers model (Figure 14) which is essentially a Maxwell and

Kelvin-Voigt model connected in series.

The strain dependence of a Burgers model can be determined by combining both mathematical expressions to give the following equation.

$$\gamma = \sigma \left(\frac{1}{G_1} + \frac{1}{G_2} \left(1 - e^{-t/\lambda} \right) + \frac{t}{\eta_2} \right)$$

Creep Testing

The test protocol described in the previous section whereby a constant stress is applied to a visco-elastic material and the strain response measured is what is called a creep test. This kind of measurement is usually applied to solid-like materials like metals which creep on long timescales rather than flow, although the test is applicable to all kinds of visco-elastic material. The test involves applying a constant shear stress over a period of time and measuring the resultant shear strain. The test must be performed in the linear visco-elastic region (see next section) where the microstructure remains intact. The measured response in a creep test is usually presented in terms of the creep compliance $J(t)$ which is the ratio of the measured strain to the applied stress, or inverse modulus.

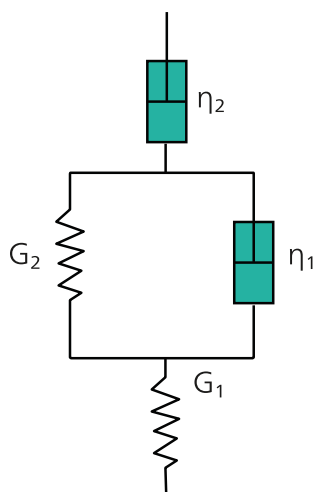

14 Representation of a Burgers model which combines Kelvin-Voigt and Maxwell elements in series

A Basic Introduction to Rheology

A typical creep and recovery profile for a material showing Burgers type behavior is shown in Figure 15. An initial elastic response is first observed, followed by a delayed elastic response and finally a steady-state (linear) viscous response at longer times. The gradient of this line at steady state is equal to the strain rate and can therefore be used to calculate the zero shear viscosity of the fluid. If the steady-state linear response is extrapolated back to zero time, then the intercept is equal to the equilibrium compliance (J_E). This is the compliance or strain response associated with just the elastic components of the material, i.e., springs in the Burgers model. The recovery step begins once steady state has been attained and involves

removing the applied stress and monitoring the strain as the stored elastic stresses relax. Only the elastic deformation of the sample is able to recover fully because the viscous deformation is permanent, and J_R the recovery compliance, should eventually equal J_E . To accurately model the response of real systems in creep testing, it is often necessary to use multiple Kelvin-Voigt elements.

If a material has a true yield stress, then no steady state response is observed; η_2 will then be infinite and the creep compliance will plateau to the equilibrium compliance (J_E), as shown in Figure 16.

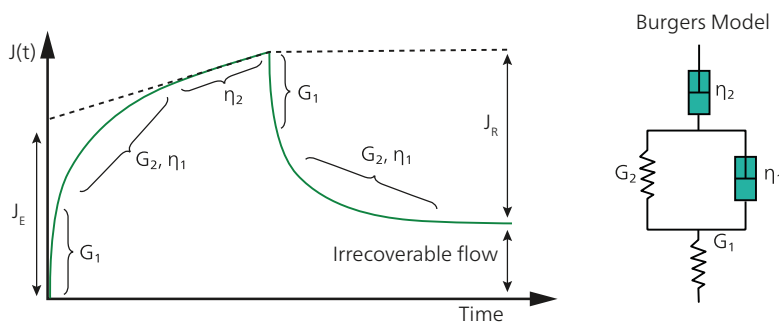

15 (right) representation of a Burger model and (left) expected profile of a Burger model undergoing creep and recovery testing with equilibrium compliance (J_E) and recovery compliance (J_R)

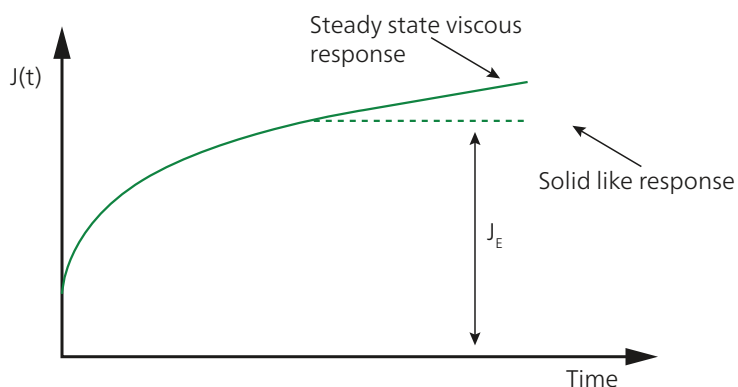

16 Expected creep response for a viscoelastic liquid and viscoelastic solid

Small Amplitude Oscillatory Testing

The most common method for measuring visco-elastic properties using a rotational rheometer is small amplitude oscillatory shear (SAOS) testing where the sample is oscillated about its equilibrium position (rest state) in a continuous cycle. Since oscillatory motion is closely related to circular motion, a full oscillation cycle can be considered equivalent to a 360° or 2π radian revolution. The amplitude of oscillation is equal to the maximum applied stress or strain, and frequency (or angular frequency) represents the number of oscillations per second.

To perform oscillation testing with a parallel plate measuring system, the sample is loaded between the plates at a known gap (*h*) and the upper plate oscillated back and forth at a given stress or strain amplitude and frequency

(Figure 17). This motion can be represented as a sinusoidal wave with the stress or strain amplitude plotted on the y-axis and time on the x-axis. In a controlled stress measurement, an oscillating torque is applied to the upper plate and the resultant angular displacement measured from which the strain is calculated. In a controlled strain experiment, the angular displacement is controlled and the torque required to give that displacement is measured, from which the shear stress can be calculated.

The ratio of the applied stress (or strain) to the measured strain (or stress) gives the complex modulus (**G***) which is a quantitative measure of material stiffness or resistance to deformation, where

$$|G^*| = \sigma_{max} / \gamma_{max}$$

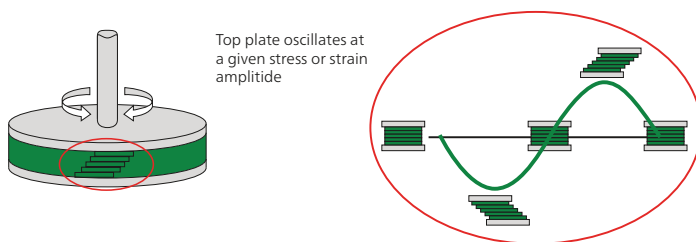

17 Illustration showing a sample loaded between parallel plates with an oscillatory (sinusoidal) shear profile applied

Phase Angle

For a purely elastic material (stress is proportional to strain), the maximum stress occurs at maximum strain and are said to be in phase. For a purely viscous material (stress is proportional to strain rate), the maximum stress occurs when the strain rate is maximum (when flow rate is greatest) and stress and strain are out of phase by 90° or $\pi/2$ radians (quarter of a cycle). For a visco-elastic material, the phase difference between stress and strain will fall somewhere between the two extremes. This is illustrated in Figure 18.

measure of the materials viscous and elastic characteristics. For a purely elastic material, δ will have a value equal to 0° , while a purely viscous material will have a δ value equal to 90° . Visco-elastic materials demonstrating both characteristics will have a δ value between 0 and 90° , with 45° representing the boundary between solid-like and liquid-like behavior. This value may be considered indicative of a gel (or sol) point which signifies the onset of network formation (or breakdown). The phase angle is often expressed in terms of the loss tangent ($\tan \delta$), particularly when working with polymer systems.

It is this phase difference which allows the viscous and elastic components contributing to the total material stiffness (G^*) to be determined; the phase angle δ being a relative

Using trigonometry, it is possible to determine the viscous and elastic contributions to G^* as shown by the vector diagram in Figure 19.

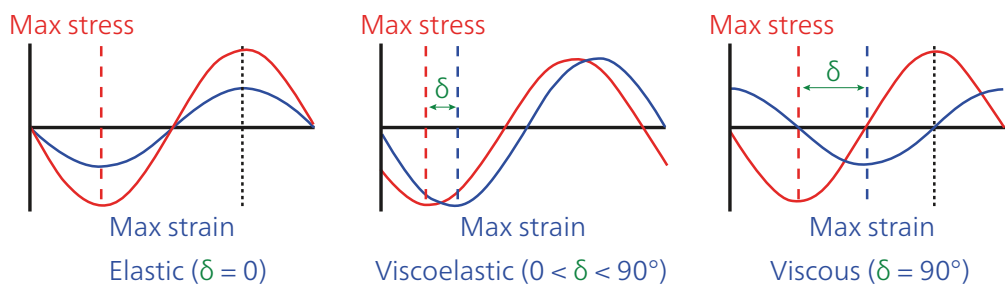

18 Stress and strain wave relationships for a purely elastic (ideal solid), purely viscous (ideal liquid) and a viscoelastic material

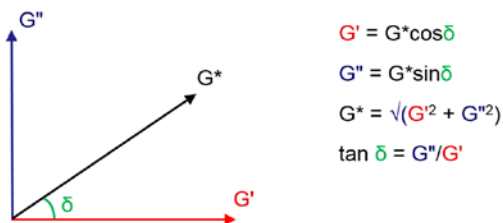

19 Geometric relationship between G^* and its components G' and G''

A Basic Introduction to Rheology

The elastic contribution to G^* is termed the storage modulus (G') since it represents the storage of energy. The viscous contribution is termed the loss modulus (G'') since it represents energy loss. An alternative mathematical representation makes use of complex number notation since G^* is a complex number (hence complex modulus) and i is the imaginary number equal to $\sqrt{-1}$. G' can be considered to represent the real part and G'' the imaginary part of G^* . These are orthogonal on an Argand diagram, which graphically represents the complex plane, with the x-axis the real axis and y-axis the imaginary axis. An Argand diagram is shown in Figure 20.

The relationship can be expressed in the following form.

$$G^* = G' + iG''$$

It is also possible to define a complex viscosity η^* which is a measure of the total resistance to flow as a function of angular frequency (ω) and is given by the quotient of the maximum stress amplitude and maximum strain rate amplitude.

$$\eta^* = G^* / \omega$$

As with G^* , η^* can be broken down into its component parts which include the dynamic viscosity (η') and the storage viscosity (η''). These represent the real and imaginary parts of η^* , respectively.

$$\eta^* = \eta' + i\eta''$$

Linear Visco-Elastic Region (LVER)

It is important when measuring the visco-elastic characteristics previously defined that measurements are made in the materials linear visco-elastic region, where stress and strain are proportional. In the LVER, applied stresses are insufficient to cause structural breakdown (yielding) of the structure and hence microstructural properties are being measured. When applied stresses exceed the yield stress, non-linearities appear and measurements can no longer be easily correlated with micro-structural properties. The linear visco-elastic region can be determined from experiment by performing a stress or strain sweep test and observing the point at which the structure begins to yield (Figure 21). This corresponds to the point at which G' becomes stress or strain dependent.

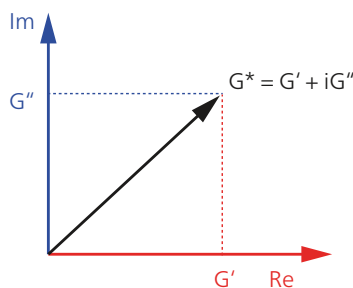

20 Argand diagram showing the relationship between G' and G'' and G^* in the complex plane

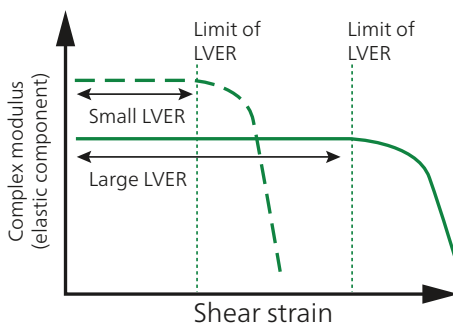

21 Illustration showing the LVER for different materials as a function of applied strain

Oscillatory Frequency Sweep

Visco-elastic materials show time dependence hence G' and G'' are not material constants. In a creep test, this time dependence is measured directly by monitoring the creep compliance with time of applied stress. In an oscillatory test, time dependence can be evaluated by varying the frequency of the applied stress or strain, with high frequencies corresponding to short time scales and low frequencies to longer time scales, since $\omega \approx 1/t$. A frequency sweep performed on a visco-elastic liquid (representative of Maxwell type behavior) yields a plot of the type shown in Figure 22, since for a Maxwell model (Figure 13) G' and G'' vary with angular frequency according to the following expressions:

$$G' = \frac{G (\omega\tau)^2}{1 + (\omega\tau)^2}$$

$$G'' = \frac{\eta \omega}{1 + (\omega\tau)^2}$$

At high frequencies, G' is larger than G'' and therefore, solid-like behavior predominates ($\delta < 45^\circ$), while at lower frequencies, the situation is reversed with G'' and therefore, liquid like behavior dominant ($\delta > 45^\circ$). The frequency at which G' and G'' cross ($\delta = 45^\circ$) is equal to $1/\tau$, with τ the relaxation time or time for the elastic stress to decay by approximately 63% of its initial value. This

process is called stress relaxation which is why such plots are often called relaxation spectrums – stored elastic stresses are relaxed through rearrangement of the micro-structure and converted to viscous stresses. Knowing the longest relaxation time of a material (real materials can have a spectrum of relaxation times) can be useful for predicting the visco-elastic response of a material stressed for a given time. This can be assessed by means of the Deborah number (De) which is the ratio of the relaxation time (τ) to the test time, or time period over which stress is applied (t). Consequently, ($De > 1$) indicates solid-like behavior while ($De < 1$) indicates liquid-like behavior.

A frequency sweep performed on a visco-elastic solid representative of a Kelvin-Voigt model is more straightforward since G' is equal to the modulus of the spring, G , and frequency independent, while G'' is equal to $\eta\omega$ and linearly dependent on frequency. Hence, G' is constant and dominates at low frequencies while G'' decays with decreasing frequency but dominates at high frequencies. This kind of behavior tends to be seen in glass-like materials.

For a gel-like material, G' and G'' are parallel and δ is constant with a value between 0 and 45° . A suitable mechanical model for describing gel-like behavior is a spring in parallel with a Maxwell element. Both visco-elastic solid and gel-like systems show yield stress behavior since they require any associated structure (represented by single springs in their respective models) to be broken for macroscopic flow to occur.

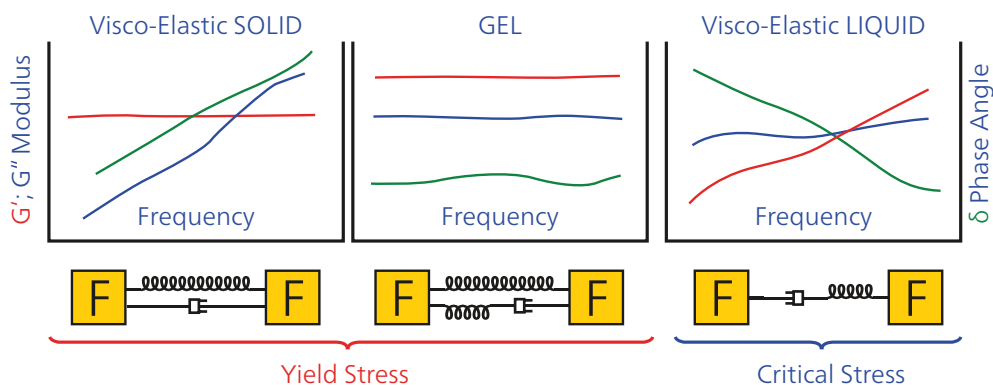

22 Typical frequency response for a visco-elastic solid, visco-elastic liquid and a gel in oscillatory testing

The Visco-Elastic Spectrum

The visco-elastic response of real materials can be considered as a combination of Voigt and Maxwell elements, such as the Burgers model (Figure 14) with the former representing behavior at very high frequencies and the latter at lower frequencies. A typical viscoelastic spectrum for an entangled polymer system spanning a range of frequencies is shown in Figure 23. It is often only possible to observe a portion of this spectrum using standard rheometric techniques depending on the sensitivity of the rheometer and the relaxation time(s) of the material under test.

A principle, which is widely used to extend the relaxation spectrum to include long time relaxation processes is the time-temperature superposition principle, which makes use of the concept that time and temperature are equivalent for visco-elastic materials throughout certain regions of behavior. As a result, higher frequencies can be used at higher temperatures to predict low frequency behavior at lower temperatures. The resultant curves can then be shifted by a pre-determined factor to give a master curve.

Another technique which can be used for reducing the time required for collection of frequency data is creep testing. Although not mathematically straightforward, there are algorithms for transforming $J(t)$ to $G'(\omega)$ and $G''(\omega)$ and their associated parameters. Microrheological techniques can also be used for extending visco-elastic measurements to high frequencies, especially for weakly structured materials.

Finally, another important rule which allows steady shear viscosity data to be predicted from oscillatory data is the

Cox-Merz rule, which states that the complex viscosity as a function of frequency is equivalent to the steady shear viscosity as a function of shear rate. This rule seems to hold for simple solutions including polymer melts, however, more complex dispersions may show variations.

References

- [1] Barnes HA; Handbook of Elementary Rheology, Institute of Non-Newtonian Fluid Mechanics, University of Wales (2000)
- [2] Shaw MT, Macknight WJ; Introduction to Polymer Viscoelasticity, Wiley (2005)
- [3] Larson RG; The Structure and Rheology of Complex Fluids, Oxford University Press, New York (1999)
- [4] Rohn CL; Analytical Polymer Rheology – Structure-Processing-Property Relationships Hanser-Gardner Publishers (1995)
- [5] Malvern Instruments White Paper – Understanding Yield Stress Measurements
- [6] Larsson M, Duffy J; An Overview of Measurement Techniques for Determination of Yield Stress, Annual Transactions of the Nordic Rheology Society Vol 21 (2013)
- [7] Malvern Instruments Application Note – Suspension stability; Why particle size, zeta potential and rheology are important
- [8] Malvern Instruments White Paper – An Introduction to DLS Microrheology
- [9] Duffy JJ, Rega CA, Jack R, Amin S; An algebraic approach for determining viscoelastic moduli from creep compliance through application of the Generalised Stokes-Einstein relation and Burgers model, Appl. Rheol. 26:1 (2016) conditions of the test.

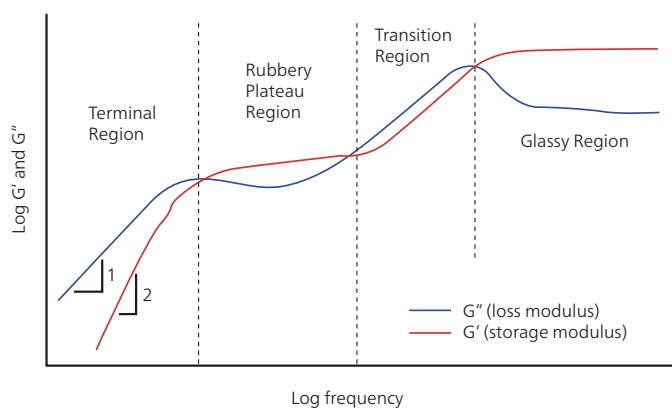

23 A typical visco-elastic spectrum for an entangled polymer system